

31 580 SD1 K700 STAINLESS STEEL SINK

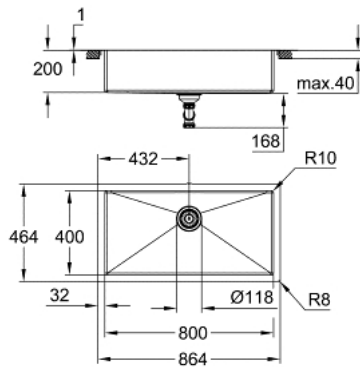

PRODUCT DESCRIPTION

- Colour: stainless steel
- model: K700 90-S 86.4/46.4 1.0
- mounting type: undermount, top mount or flush mount
- material: stainless steel AISI 304 (V2A)
- material thickness: 1 mm
- GROHE LongLife finish
- finish: satin finish
- GROHE Whisper
- min. cabinet size: 900 mm
- dimensions: 864 x 464 mm
- 1 bowl: 800 x 400 x 200 mm
- outer radius: R11 (undermount)/R3 (topmount), inner bowl radius: R10
- GROHE FastFixation installation system
- cut-out (undermount): 802 x 402 mm (R11)
- cut-out (top mount): 849 x 449 mm (R3)
- cut-out (flush mount): 849 x 449 mm (R3) (top step outer size: -865 x 465 -R8 deep -3.5 mm)
- drainer: Ø 3.5" basket strainer waste
- accessories included: waste kit, basket strainer waste, mounting set
- optional: push to open excenter (40 986 SD0)
- amount of fasteners included (top mount): 8
- amount of fasteners included (undermount): 8

31 580 SD1 K700 STAINLESS STEEL SINK

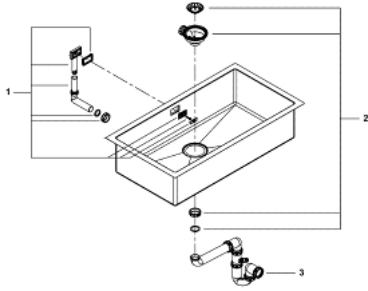

SPARE PARTS

- 1: Plug (Spare part-nr. 42589SD1)
- 2: Cover element (Spare part-nr. 42590SD1)
- 3: Siphon (Spare part-nr. 42616000)